



WOODWORKING

Project Guide

LEVEL 2



CANADA
4-H Alberta

The 4-H Motto

“Learn To Do By Doing”

The 4-H Pledge

I pledge:

My **head** to clearer thinking,

My **heart** to greater loyalty,

My **hands** to larger service,

My **health** to better living,

For my club, my community,

my country, and my world.

Published by 4-H Alberta for the 4-H community.

For more information or to find other helpful resources,
please visit the 4-H Alberta website at www.4hab.com.

TABLE OF CONTENTS

Level Two Objectives	1
Achievement Day Requirements	3
Additional Resources	5
Safety in the Woodworking Project	7
Safety Contract (to be signed).....	9
Drawing for Building.....	11
Tools	15
Using Screws as Fasteners.....	25
Measurement Tools	27
Gluing	31
Sanding.....	33
Cutting Angles	37
Finishing	39
Things to Make.....	41
Members: I Can Checklist.....	59
Evaluation	63



LEVEL TWO OBJECTIVES

Members will be able to:

- Work safely with wood to produce personal projects made of wood.
- Identify and use woodworking tools and supplies in a safe manner.
- Challenge themselves with a variety of projects and varying levels of complexity of tasks in woodworking.
- Work cooperatively with others in a workshop environment.
- Develop skill in decision making, leadership, problem-solving, finances and communication.



ACHIEVEMENT DAY REQUIREMENTS

Level Two:

- Completed Record Book
- At least two projects which demonstrate the use of different finishing techniques and which required use of power tools.
- For one of the completed projects, the plans and a cardboard model of the project.
- Example showing the use of filler and wooden plugs. (If used in member's project, additional examples are not necessary.)
- Example of a mitred corner, either in a project or as a model. (If used in member's project, additional examples are not necessary.)



ADDITIONAL RESOURCES

People

- local woodworkers
- teachers
- family members
- other 4-H members or leaders

Places, Events and Organizations

- local woodworking clubs
- exhibitions and fairs that have a woodworking class
- colleges that offer woodworking, design, or similar courses
- displays
- museums sometimes have displays with wooden articles

Books

- ***Workshop Tips and Techniques***. Editors of Cy DeCrosse Incorporated, in cooperation with Black and Decker. Minnetonka, Minnesota: Cy DeCrosse Incorporated, 1991.
- Starr, Richard. ***Woodworking with Your Kids***. Newton, Connecticut: The Taunton Press, 1990.
- McGuire, Kevin. ***Woodworking for Kids***. New York, New York: Sterling Publishing Co., 1993.
- Lento, Robert. ***Practical Woodworking Techniques***. New York, New York: Sterling Publishing Co., 1999.
- Peters, Rick. ***Controlling Dust in the Workshop***. New York, New York: Sterling Publishing Co., 2000.

Magazines

- Woodworkers Journal
- Canadian Home Workshop
- Wood Magazine
- American Woodworker

Web sites

www.thewoodcrafter.net
www.leevalleytools.com
www.woodworkershop.com
www.intheworkshop.com
www.uniqueprojects.com
www.am-wood.com (Amateur Woodworker)
www.northpolechristmas.com
www.tdc.ca/ewebster.htm
www.feesa.ab.ca
www.woodlinks.com

SAFETY IN THE **WOODWORKING PROJECT**

List as many preventative actions as you can for the following risks:

AT RISK	RISK	PREVENTATIVE ACTION
EYES	Flying chips Dust Splashing finishes Splinters from breaking tools Fumes Compressed air used improperly	
EARS	Exposure to loud noises	
LUNGS	Exposure to very tiny dust particles (less than 10 microns) Exposure to fumes from finishes Inadequate ventilation	
SKIN, FINGERS, LIMBS, HANDS AND FEET	Punctures, rips from tools and rough wood. Crushing Pinching Exposure to chemical finishes Abrasions Burns from hot tools	
BACK	Lifting too much Falls from tripping over materials Turning incorrectly Lifting incorrectly	

*You must purchase your own personal safety equipment for the 4-H woodworking project.
Eye protection must be worn.*



Who does an unsafe worker affect?

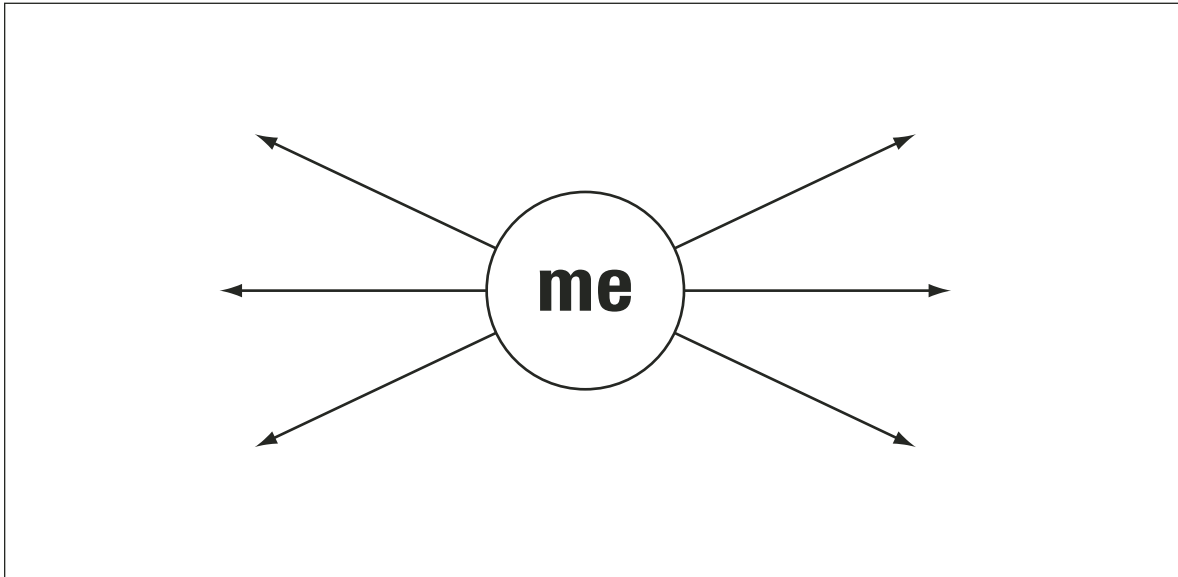

Safety Steps

1. Name the risks
2. Safeguard the work area.
3. Wear necessary protective equipment.
4. Use the right tools.
5. Follow correct procedure.
6. Monitor work habits.
7. Correct as necessary.

Ensure all helpers follow safe procedures

- Where are the First Aid kits kept at your 4-H meetings?
- Where are all the First Aid kits at home?
- Who has First Aid training in your 4-H club?
- Who has First Aid training in your family?
- What phone number do you call for emergency help?
- What are the directions to drive to your meeting place? (In case you ever had to give them to emergency people)
- What are the directions to get to your home? (In case you ever had to call emergency people)
Post these by all the phones in your home or shop.

Contents for a Basic First Aid Kit

A variety of bandages; antiseptic; tweezers; First Aid booklet; cotton swabs; sterile gauze; First Aid tape; needles (to get out slivers); eye drops.

SAFETY CONTRACT

I Will:

- identify risks of activities
- take actions to eliminate or reduce risk
- ask for help when needed
- select the correct tools, equipment and materials for activity
- watch for and allow for closeness to other people
- stop work and move back when ask to
- exit work area on command (in case of emergency)
- return tools and supplies to storage after use
- follow safe disposal procedure
- dress appropriately for club activities
- share responsibility for safety in the club

Member

Parent

Leader

Date

DRAWING FOR BUILDING

Benefits of Drawing a Project before Building it

- helps you better understand how the project will fit together
- helps you think through the stages of the project and anticipate what you will be doing and what you will need
- a good drawing makes for a good project

Benefits of building a paper or cardboard model of a project

- allows you a dry run at the project
- helps you understand how things fit together
- you can test and adjust size, if necessary
- it helps keep you on track and prevents mistakes
- it can encourage you!
- you can try out different stains on paper instead of wood

Isometric Drawings

- Shows what an object would look like from one side and a bit below your eyes (like looking down at something sitting on a table)
- Is helpful for getting an idea of what the project will look like
- Helps indicate what type of materials will be needed

Sketch an example of an isometric drawing here.

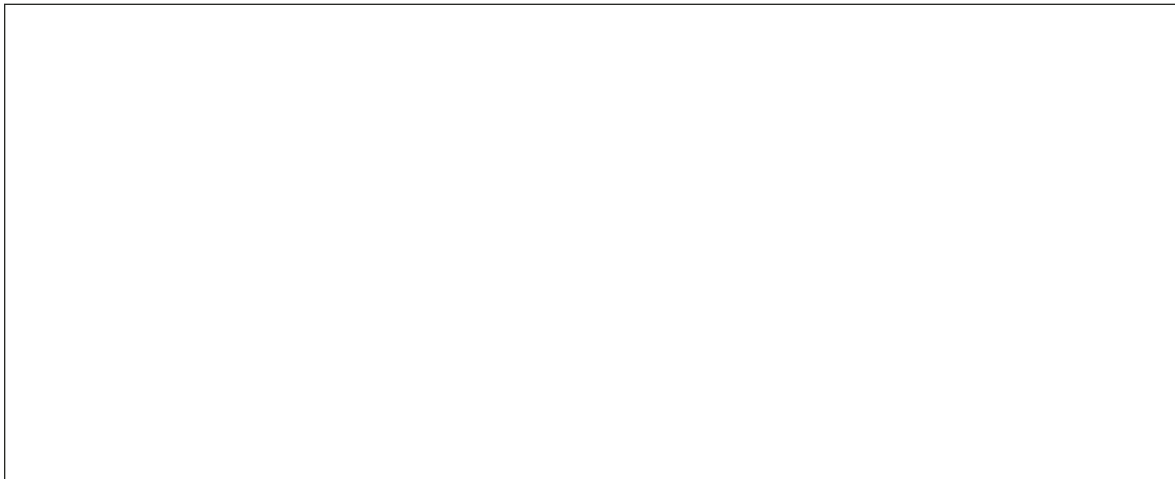

Orthographic Drawing

- This type of drawing splits the object into different views: the top, the sides and the front
- An orthographic drawing is drawn accurately and to scale*

* *to scale means that each measurement on paper is in proportion to a measurement in real life. e.g. One cm on paper represents 10 cm in real life.*

Sketch an example of an orthographic drawing here.

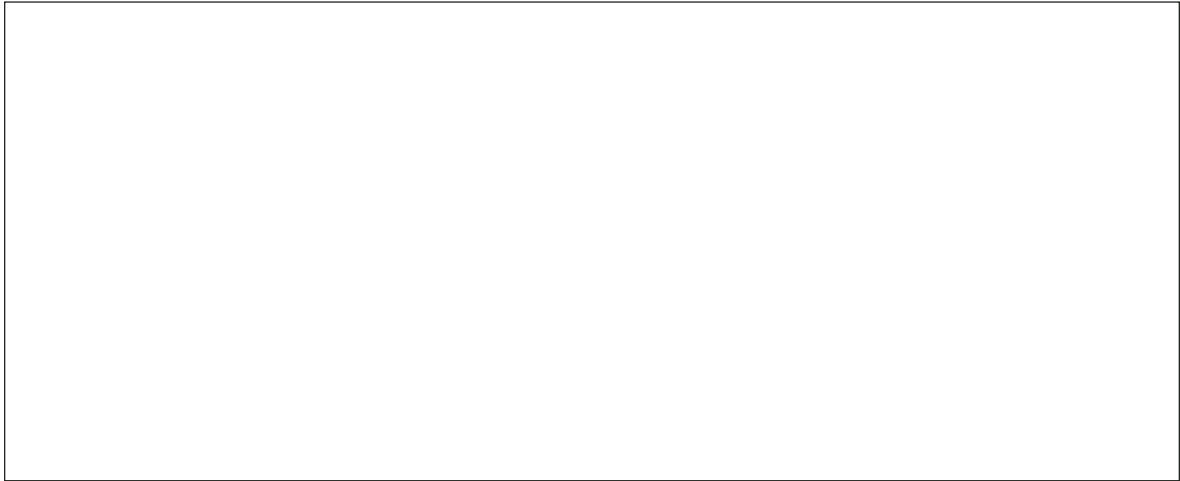

Practice

Materials

Small box or rectangular object, ruler or tape measure, unlined paper, pencil, eraser

Procedure

1. Draw an isometric drawing of a box here.



2. Measure the box. Draw the box in isometric style. Do a neat job, using your ruler for the lines. Print on all the measurements of all sides on. Put the box away.
3. Use your isometric drawing as a guide. Now draw an orthographic drawing. Make the scale 1 to 2 (one cm on paper means two cm on the actual box). This is written as 1:2.
4. Show the three views: top, side and front. Label neatly with all the measurements. The drawing should be exactly half the size of the box. Print 1:2 at the bottom right corner.
5. To test the accuracy of your drawing, swap orthographic drawings with another member and build a paper or cardboard box from each others drawings! Measure and cut accurately to the drawing. How do your boxes turn out?

Enlarging a Pattern

Use a photocopier with an enlarging feature. Or, since not everyone has a photocopier in the back room, use a grid system to enlarge a pattern to the size you want!

Using a Grid to Enlarge a Pattern

Draw a grid on the original pattern or on a copy of it. Number each line and letter as shown.

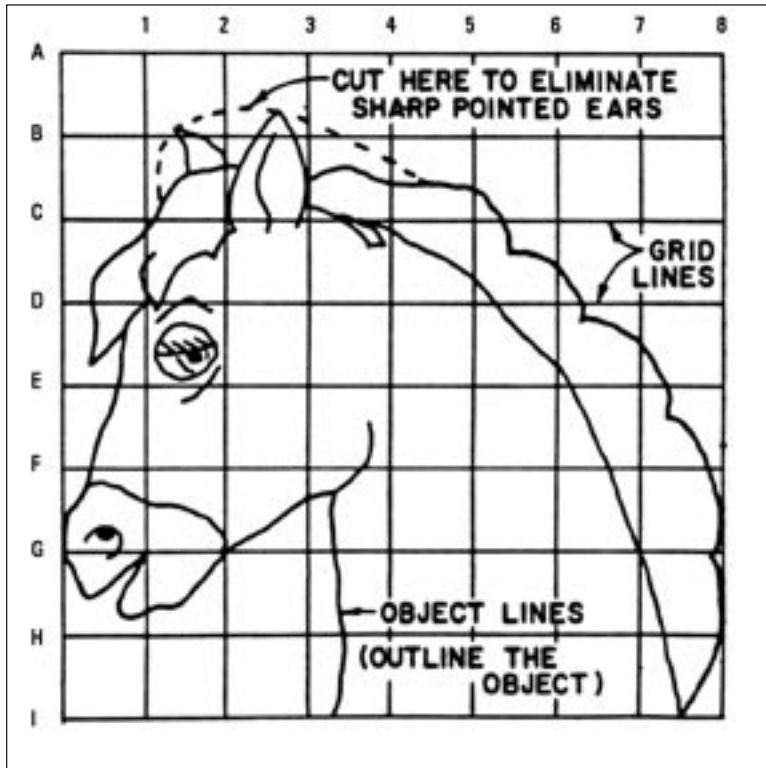

Decide the size you want the project to be. Draw a grid with larger squares to fill the space that you want the project to be. Use the same number of lines that you used on the original pattern.

See where the grid lines cross the objects lines in the first drawing? Place dots on the same points and lines on the larger pattern. When you have all the dots on the new pattern, connect the dots, using curved and straight lines like the original. The new pattern will be a larger version of the original drawing.

You will display this enlarged copy at Achievement Day!

Copying a Pattern onto the wood of a project

Use carbon paper and a dull pencil to trace a pattern onto wood. Secure the pattern with masking tape to ensure a clean copy.



Transferring with a Photocopy and an Iron

Photocopy the pattern you want. Tape the pattern onto the wood. Press with a hot iron to transfer the pattern. Check a few times to ensure the pattern is transferring completely.

If the pattern has words on it, you will have to reverse it (or the words will print backwards.) Make your first copy on tissue paper. Then turn that tissue paper over, and make a copy of it. The lines should show through the tissue well enough to copy backwards onto regular paper. Then iron the second photocopy on your wood.

TOOLS

Chisels

Chisels are sharp wood knives which are used to remove unwanted strips of wood. The end of the blade is the sharp part which cuts with a pushing action. The tip of the blade is slanted or beveled. Most chisel work is done with the bevel side down against the wood. Whenever possible, use your chisel with the grain of the wood.

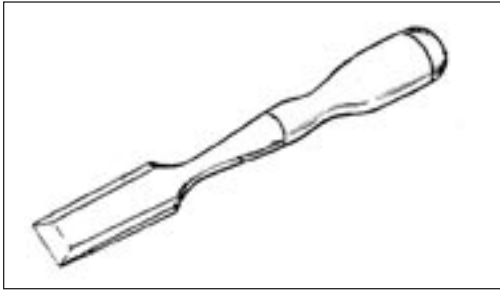

Characteristics

- very sharp
- available in a range of qualities and sizes
- need to be kept sharp so they do their best work

Safety

- chisels can easily slip and cut flesh
- keep both hands behind the chisel
- secure the wood project with a clamp or vise

Care and Storage of Chisels

- protect the blades by putting an old tennis ball or chunk of styrofoam over the end
- keep from moisture
- place them, do not throw them into the drawer
- put a piece of old carpet in the bottom of the drawer or tool box

How to Tell When to Sharpen Chisels?

- they start getting harder and harder to push (overall dullness)
- they start cutting irregularly (chips in the edge)

Power Drills

Power drills speed up the job of drilling holes. They can also speed up errors or injuries, so need to be handled carefully. Most drills will also work in reverse, which is very helpful if you have to remove screws with a special bit.



When you drill with any drill, make sure you drill straight, without putting bending pressure on the bit. Otherwise, you could spoil the bit and probably the hole you are drilling. Ask someone to watch you as you practice.



Power drills come in two formats - plug in or rechargeable. A plug in drill is stronger and works as long as there is power (makes sense!). Rechargeable drills are convenient where power is not available or for working in very tight or awkward situations. Rechargeable drills are much heavier and larger because they include a battery. They are not as powerful as plug in drills but are capable of doing the work for most 4-H projects.

When the battery runs out, replace it with a recharged battery. Follow the recharging instructions that came with the drill.

Safety Notes:

- never use an electrical tool or appliance in damp conditions
- ensure the cord is in good condition
- ensure the key is removed from the chuck before using the drill
- have a firm grip on the drill when using
- keep the bit away from skin
- secure the object being drilled so it will not spin
- ensure that the drill bit has quit spinning before setting it down
- keep long hair and loose clothing away from the drill
- drill bits get hot from friction and can burn
- ensure the drill bit is securely inserted before starting the drill

Brands we looked at:*Characteristics*

Safety Observations

Advantages of Using a Power Drill

Disadvantages of Using a Power Drill

Care and Storage of Power Drills

- gather the cord up and snug it up with the drill
- take the bit out and put it in its case or protect the bit with a chunk of styrofoam
- protect from moisture or excess dust

How to make sure I drill straight with a power drill.

Which of your projects will require the use of a power drill?

A drill can also be used to put in screws. Practice this on some waste wood.

Tip: When you need to control the depth of a hole you are drilling, stick a bit of tape on the drill bit at that depth. When you reach that depth while drilling, stop. You will be at the correct depth!



Practice using a Drill

Materials

Clamp, scrap wood, various sizes of drill bits, plug-in or rechargeable drill (or both!)

Procedure

1. Clamp the piece of wood securely. Ensure all safety steps are observed.
2. Leader demonstrates putting a drill bit in the drill. After observing, try this yourself. Have the leader check to ensure the bit is secure.
3. Practice drilling various sizes of holes.
4. Practice using both plug-in and rechargeable drills, if both are available.
5. Concentrate on drilling holes that are straight up and down.

Jigsaw

The jigsaw is an electrical tool with a small blade that moves up and down. It is used to cut both straight and curved lines. Using a jigsaw is similar to holding an iron. The teeth point upwards so the blade cuts on the upward stroke. Most jigsaws have more than one speed. The saw does its best work when set at full speed.

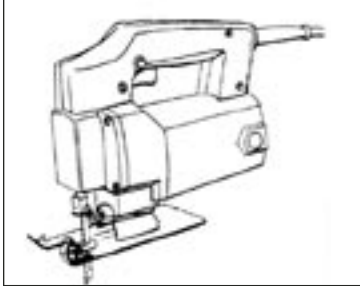

Safety

- Wear goggles to prevent injury from flying chips.
- Hold the jigsaw until the blade has completely stopped. Otherwise it will move about, injuring someone or causing other damage. Also, it looks stupid.
- Make sure whatever you are cutting with a jigsaw is secure.

Tips for Using a Jigsaw.

- sometimes you have to make separate cuts to complete cutting into a tight spot
- do not force the blade to turn too quickly or you will bend or break the blade
- start the blade going before it touches the wood

Models of Jigsaws we tried

The Jigsaw I Preferred and Why

Power Sanders

Most woodworking shops have two kinds of power sanders - the belt sander and the vibrating sander. They are used for larger sanding jobs and can use a variety of grits of sandpapers. Power sanders can do the job faster. They can also make mistakes faster and deeper than hand sanding!

Belt Sander

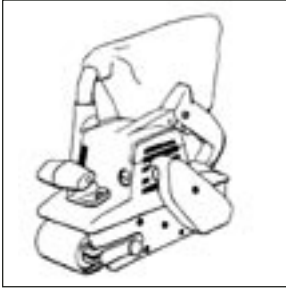

The belt sander has a loop of sandpaper which is fitted and snugged over two wheels attached to a motor. Belt sanders are quite powerful, noisy and can cause injury. Your leader will demonstrate belt sanders. As with all tools, make sure the sander has finished working before you set it down.

Vibrating sanders work by shaking or vibrating a piece of sandpaper attached to a plate which is attached to its motor. Use a vibrating sander to smooth wood surfaces and take out scratches. Most use a quarter of a sheet of sandpaper. Vibrating sanders are considered to be safer than belt sanders.

When using a vibrating sander, do not lean on it. That would wear out the bearings and also probably do a terrible job of sanding. Move the sander over the project with the grain of the wood with just the weight of the sander and your hand on it. Make sure it has stopped moving before you set it down.



Tips for Using a Sander

- Turn on the sander before touching the wood.
- Land it gently on the wood.
- Sand with the grain.
- Overlap your work a bit each time.
- Wear dust protection. Work outside when possible.
- Lift the sander off the wood, then turn it off.
- Make sure the sander has stopped completely before setting it down.
- Your sanding is only as good as your sandpaper. If your paper is worn out, replace it!

Safety

- work only in dry conditions with electrical tools
- use grounded cords in good condition
- keep the sandpaper surface away from skin

Brands of Power Sanders we looked at:*Characteristics*

Advantages of Using Power Sanders

Disadvantages of Using Power Sanders

Care and Storage of Power Sanders

How to Change the Sandpaper

Each power sander has slightly different ways to change the sandpaper. Ask for a demonstration or read the manual for the power sander you are going to use.

Hand Drill

This is a great tool that looks like an eggbeater! It has a clamp at one end called a chuck that will hold different sizes of smaller drill bits. It is powered by turning the crank.



To Chuck (install) a Drill Bit

Hold the drill in one hand. Twist the chuck until it opens up. If the chuck seems to be stuck, hold the chuck while you turn the crank a bit. Slide the flat end of the bit all the way up into the chuck, then tighten the chuck against the bit.

To Drill a Hole

Dimple the spot where you want to drill a hole by tapping a nail there with a hammer. This makes a small hole so your drill will not move. Set the bit in the dimple. Hold the drill handle with one hand, pressing down on it as you turn the crank. Hold the hand drill straight up and down so the hole will be straight.

To remove the drill from the hole, turn the crank the opposite direction.

To Drill a Hole a Certain Depth

Measure the depth on the bit, then stick some duct tape at that spot. Stop drilling when you reach that piece of tape.

Drilling Pilot Holes for Screws

Screws go into wood much more easily if you drill a pilot hole. Choose a bit that will remove most of the wood, while leaving enough for the screw to grip on.

Practice

Materials

Hand drill, bits, scrap wood, screws, screwdriver

Procedure

1. Screw a screw into the wood without a pilot hole.
2. Choosing a bit that is smaller than the screws you are using, drill a pilot hole.
3. Screw the screw into the pilot hole. Compare the effort needed for both jobs.
4. Practice drilling holes straight up and down.

Brace and Bit

We use this tool to drill larger holes. It looks like something from a dental nightmare! The brace and bit is a very old design that has stood the test of time. It was used to make the ships that brought many of our ancestors to Canada and many of the historic buildings in our country. Watch for used ones at auctions. They are valuable additions to your tool box.

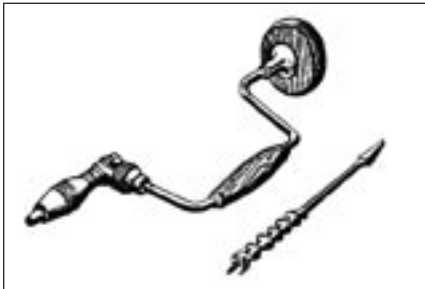

The brace is the curved metal which has a small knob handle at the end and another longer handle on the bumped out middle section. At the working end there is a chuck which holds the bits.

The bits have three parts - a square or rounded end that fits into the chuck; a spiral shaft, and a screw-tipped end. Bits come in many sizes.

Using a Brace and Bit

Because of its spiral design, the bit actually pulls itself into the wood as you crank the brace! The sharp tip on the bit does its own dimpling of the wood.

Hold your brace and bit straight up and down when drilling so the hole will be straight.

Put a piece of scrap wood under your project so you do not make a series of holes in the work bench.

To remove the bit when the hole is complete, pull it up and out.

Tip: Some braces have a switch or collar that you have to adjust to tighten the chuck, for removing the bit from the hole.

Sometimes it helps to put your project down on the floor and kneel on it while you are using the brace and bit. It is quite a big tool and it helps to be above it when using it.

USING SCREWS AS FASTENERS

Screws have three parts- the head, the shank and spiral threads ending in a sharp point. The spiral threads pulls the screws into the wood as you turn the screwdriver. Screws hold pieces of wood together by gripping the wood with the threads. Never hammer screws into wood.

Different Screw Heads

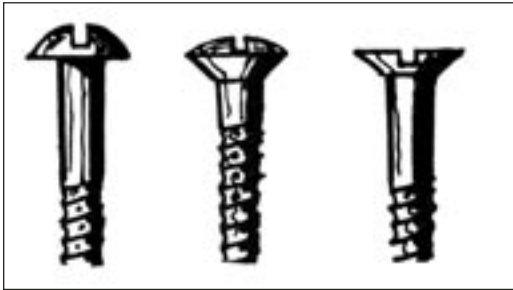

Screws come in many shapes and sizes. The most common size of screw is the #8. Thickness ranges from #4 to #12.

The most common styles of screwdrivers are the slot, the Phillips and the Robertson.

The slot screw features a simple groove cut across its head. Screwdrivers can easily slip from this groove and damage the wood.

The Phillips or star head is used more often in cars and metal work than in woodworking.

The Robertson or square socket is favoured for woodworking in Canada. The right sized screwdriver tip fits snugly in its square head.

Use of Pilot Holes

Drill a small pilot hole that is smaller than the screw you will be using. This will prevent the wood splitting. It will also make driving the screw an easier job.

Using a Power Drill to Drive Screws

You can drive screws with a power drill with a special attachment. Make sure you use the right size of screwdriver tip or you will ruin the head of the screw.

When the screw is as far as it will go into the wood, STOP! Otherwise you will ruin the head.

Camouflaging Screw Holes in Projects

Use putty to cover up screws. Let it dry. Sand.

Use wooden plugs that have been finished the same way as the project. If there is a grain showing in the plug, make sure the grain runs the same way as the grain in the project.

MEASUREMENT TOOLS

Marking Gauge

Use a marking gauge to mark a uniform width on a board, for cutting or for marking where to drive screws.



Set the pin at the desired distance from the face of the head and check it with a ruler. Sometimes the pin can get bent and this alters the accuracy of the scale on the gauge. When you have the correct measurement, tighten the pin.

Push the gauge forward when marking. Turn the gauge slightly so that both the beam and the pin touch the wood at the same time. This lets you see what the pin is doing. Make sure you keep the face of the gauge against the wood edge, so your mark is accurate.



Look at the picture. Give advice to this woodworker to correct her use of the marking gauge.

T – Bevel

This is a very useful tool and also a very old design. Use a T bevel to lay out mitres or to test mitred corners or beveled or chamfered edges. Another valuable use is duplicating an existing angle. Loosen the screw to free the blade. Find the angle you are checking, then tighten the screw.



Try Square

Use a try square to test for right angles in lumber or to test for squareness in projects.

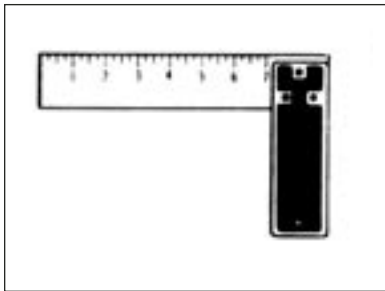

Steel Utility Square or Framing Square

Builders use this square to construct buildings. Its greater length makes it more accurate.

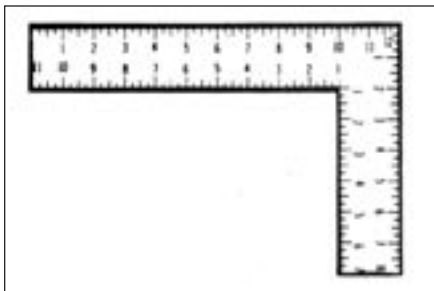

Steel Combination Square

A combination square can measure for both 45 and 90 degree angles. It can be used to measure for mitre joints. This tool is also adjustable. It is a very handy tool to have in the tool box.

You can use the combination square to mark a line a uniform distance from the edge of a board. Decide how deeply you wish to mark the board and set the blade to that depth. Hold the square securely against the edge of the board. Hold an awl at the end of the blade which is at the correct depth. Mark the wood with the awl as you slide the square along the edge.

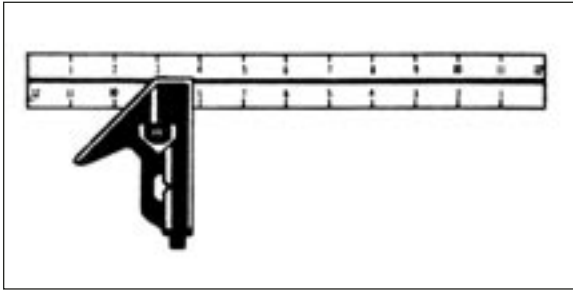

Pencil Compass

Use the compass to draw circles for projects. Set the compass so that the pencil tip and needle point meet when the compass is closed. Always have a piece of cardboard or scrap wood under the compass point so you do not scratch surfaces underneath.

Scratch Awl

Use a scratch to mark wood precisely for cutting. An awl is extremely sharp and strong. Handle with extreme caution and store carefully.

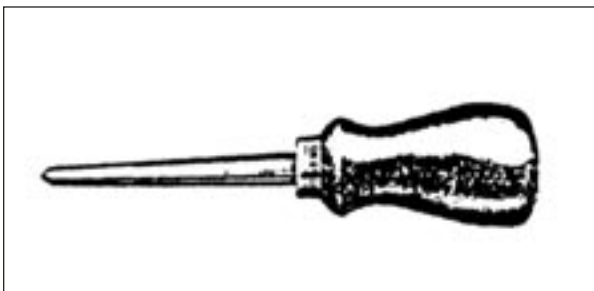

Care of Tools

- Store tools where they will not be dropped or bumped by other tools or materials.
- Use tools only for what they were designed.
- Use the correct size of tool for the job.
- Never force a tool.
- Secure tools so they will not drop off work surfaces or hangers.
- Keep them as clean as you can.
- Some people make or buy fabric socks for some of their more delicate tools, such as planes. This protects them from damage and dirt.
- It also keeps them out of sight from potential thieves. Tools are also prime targets for thieves.
- For pointed tools, protect the point (and your fingers) by storing the point in an old tennis ball or wrap in a piece of dry canvas or leather.
- Label tools with your name and phone number, if possible. This will prevent mix-ups at meetings.

GLUING

Glue is usually used with nails or screws. This is a very strong combination. Glue works by being absorbed by both wood surfaces. It actually enters into the layers of wood and forms a bond with it. When we hold the two wooden surfaces together as the glue dries, they become bonded.

The two most common glues used by woodworkers are white glue and yellow glue (carpenter's glue).

Prepare Wood for Glue

Glue works best when the surfaces are clean, dry and free of dust. It is important that the wood pieces fit together well, with no gaps. Hold them together without glue to be sure that they fit well.

It is important to hold the pieces together while the glue is setting, so that the bond can form. Be careful not to press them together so tightly that the glue squeezes out.

Tip: To spread glue more evenly over a large surface, make a glue spreader out of an old credit card (or similar hard plastic card). Trim the long edge of the card with pinking sheers to help with the spreading.

Clamping

Choose a means of clamping the pieces of wood that will keep them snugly without damaging the wood. Woodworkers use clamps, pieces of inner tube, rope, clothes pins and other contraptions to secure the wood while the glue dries. Allow the project to dry well before proceeding to the next step of construction.

The combination of glue on a metal clamp can make a stain on wood. Cover metal clamps with masking tape where glue might touch them.

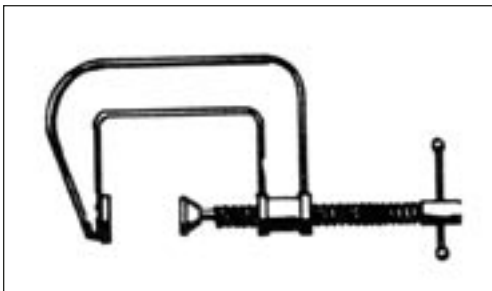

Tip: You can use a drinking straw to pick up excess wet glue at a joint. Push the end of the straw against the seam until it conforms to the shape of it. Then push it along the wet glue, to pick it up.

Clean Up

Use a warm, damp, clean rag to wipe up wet dribbles. Glue dries clear but will interfere with finishes. (Stains will not absorb into the wood at a glue spot.)

Storage of Glue

Store glue where it will not freeze or be in direct sunlight. Ensure the container is sealed to prevent the entry of air. If the original cap is weak or faulty, try a mاریette, the screw type cap used to connect electrical wires. The screws in the mاریette will dig into the plastic of the spout and block air entry.

Some woodworkers like to store their small bottles of glue upside down so that the glue is ready to go. (These are woodworkers who are sure that their glue lids are secure!). You can store glue bottles upside down in a coffee can or even build a wooden holder that looks like a giant toothbrush holder.

Tip: You can put a large headed nail into the tip of a glue bottle, then put on the cap. Pull the nail out to clear the tip out before you use it next time.

Practice

Materials

Types of glues, scraps of clean wood, painted wood and dirty wood, a variety of materials to use as clamps.

Procedure

1. Glue two dirty or greasy pieces of wood together. Clamp and let dry.
2. Glue two clean pieces of wood together. Clamp and let dry.
3. Glue two pieces of painted wood together. Clamp and let dry.
4. Compare the strength of the examples at the next meeting. Your conclusions? How will these joints stand up over time?
5. Practice gluing pieces of wood together and determining how much glue is enough. Practice cleaning off excess glue with a warm, damp, clean cloth. Maybe later you can practice staining this piece and see how the glue affects the staining process.
6. Compare the types of glues that you have. What differences do you notice in how the glue flows, sticks, smooths, and bonds?

Observe

Look around home, school and public places to see places where glue has been used.

Sometimes you will see fine examples of gluing. Other times it will look like a glue fight happened. Learning how to glue effectively and neatly is an important skill to develop.

Sometimes you will see very old examples of gluing that still work. Other times you will see where the glue has failed. Often woodwork has to be taken apart, scraped well, reglued and clamped. For example, kitchen chairs that get a lot of use often need regular regluing. (Whether they get it is another item.)

SANDING

You will collect a variety of grits of sandpaper as you work on more and more projects. Keep your sandpaper in a dry place, sorted by grit.

Hand sanding is the ultimate and most precise sanding that wood can receive. But we often use sanding machines to do some of the work. Choose the correct machine to do the job.

Sanding machines can be heavy and require a certain amount of strength and stamina. If you find yourself getting tired, stop.

Using a Power Sander

Turn on the sander before touching the wood. Land it gently on the wood.

Hold the sander firmly. Do not press down. The weight of the machine itself and the guidance of your hands are all that is usually required. Sand with the grain. Overlap slightly, parallel to the grain. When finished, lift the machine off the wood, then switch it off. Make sure it has stopped before you set it down.

Sand lightly. You can always sand again. You cannot replace a layer of wood that you hastily removed.



Belt sanders

Operate with a circle of sandpaper powered by a small motor. The sandpaper comes in a range of grits. These can be quite heavy.

Orbital Sanders

Move in a circle, up to 20,000 spins in a minute! That could also mean 20,000 scratches a minute!

Keeping dust to a minimum

It is best to trap dust at the source. Many sanders have a dust attachment. Keep this on and empty it regularly.

- Wear a proper respirator.
- If weather permits, do your sanding outside.
- This woodworker is sanding outside. She could still benefit from wearing dust protection.
- Sweep often.
- Vacuum dust up regularly with the shop vacuum.
- If your work area has a dust management system, clean out the filters regularly.



Practice Using Various Types of Sanders

Materials

Scraps of woods (different roughness and hardness); a variety of sanders; eye protection; dust protection

Procedure

1. Clamp the wood to be sanded.
2. Practice using various sanders and grits of sandpaper on the wood. Compare the quality of the work done. Your thoughts?
3. Which type of sander did you prefer? Which model? How heavy was the sander? Is a power sander right for you right now or do you prefer hand sanding?

Tip: After you have just sanded a surface, dampen it lightly. This will raise any imperfections and you can sand again, producing a smoother finish!

Tip: To sand into a corner, put a bit of sandpaper on the tip of a putty knife and use that.

Tip: To sand very small parts with a sander, attach the small part to a larger piece of wood with double sided carpet tape.

Tip: Use an emery board to get into those tiny spots that need sanding.

Using Filler

Filler has a strong odor. Use in a well ventilated area!

A filler can make your project even smoother! Filler comes as a paste and is made from ground silicon, linseed oil, color, a drying agent and turpentine. It is available in natural wood color or can be matched to wood stains.

Dilute the filler with a small amount of turpentine until the paste is like thin cream. Filler for oak should be a bit thicker and a bit thinner for woods like cherry, soft maple and redwood.

Work on a small area at a time. Apply with a clean, stiff brush, completely covering the area. Brush first with the grain, then across the grain.

Go over the surface with the palm of your hand, in a circular motion. Allow to dry until it loses its shiny appearance (about 20 minutes.)

Use burlap or other rough cloth to wipe across the grain to remove the excess filler. Then use cheesecloth or thin cotton to lightly go over the surface with the grain to remove what is left. You do not want to completely remove all the filler, just the filler that is sticking up out of the pores.

If necessary, add another coat of filler. Let it dry at least 6 to 8 hours. Then cover with shellac, varnish or lacquer.

CUTTING ANGLES

Mitred corners join pieces of wood together which have been cut on an angle. They are popular for picture frames and doorways. Mitred corners are often reinforced in some way.

Why Use Mitred Corners?

Mitred corners are attractive and show off decorative wood well.

The Mitre Box and the Mitre Saw are specially designed to cut precise angles so that mitred joints fit accurately.

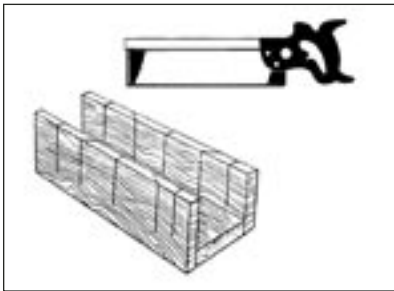

Tips for Accurate Sawing

- think your cuts through before you cut!
- hold the wood securely against the side of the mitre box
- clamp the mitre box to the work surface

Clamping a Mitred Corner

Cut a 90 angle out of a small piece of hardwood. Clamp this against a mitred corner while the glue is drying.

Care and Storage of Mitre Box and Saw

- put a thin piece of wood under the wood being sawn in the mitre box to protect the box
- keep the box clean and dry
- protect the box from items falling on it
- store the saw with the blade covered

Observe

This next week, look for mitred corners at home, school and out in the community.

- Where did you see mitred corners used?
- How strong did they appear to be?
- How attractive did they appear to be?
- Did you see any situations where a mitred corner should have been used?

Are mitred corners a relatively new development or have they been around for a while?

How can you answer this question with your own findings?

FINISHING

Some woodworkers are tempted to rush the finishing of projects. Yet it is the finishing that can make or break your project! Take the time to choose and execute your finishing technique. It will pay off.

The Benefits of Varnish

- shows off the grain and colour of wood
- looks more natural

Benefits of Paint

- can cover up flaws in the wood
- can cover up errors in workmanship
- can disguise wood filler
- can match existing furniture
- is often washable

Clean-up of Tools

It is important to clean up immediately after finishing. The longer you leave your tools and work area to dry before cleaning up, the harder the finishes are to remove. Each product will have its own instructions for clean up.

Paint brushes need to be absolutely clean before hanging up to dry, or they will be hard and totally useless to you next time.

Special Finishes

Splattering

Protect your work area. Apply a coat of primer and paint on your project. Let them dry completely. Use either an old toothbrush or small paintbrush to do the splattering.

Practice first! Choose a different color. Load the brush, scrape off the excess then pull the bristles back with a small piece of wood, so that the paint will spray. Or, you can tap the brush with a piece of wood.

Once you have mastered this technique to your satisfaction, splatter paint onto your project. You can make the splatterings as thin or thick as you like! You can also mask an area or use a stencil to produce a splattered pattern. Have fun!

Stippling

Use a stippling brush, marine sponge or paper towel on your project while the paint is still wet. You might want to practice this technique on something else first, but there is no wrong way to do it!

Rag Rolling

Roll a dry, clean ruffled rag through the paint! Doesn't that sound funny? You can also dip the rag into paint and then daub it onto a clean, dry surface. Try both!

Dragging

No, this does not require a car and a rope. Drag a comb tool through wet paint. Clean off the tool after each pass. This is especially attractive when you use a different color of wet paint over top of dry paint.

Marine Sponge

Dip your sponge into a bit of diluted paint, then wring it almost dry. Touch your project with the sponge, turning it in various ways. Try this with several colours!

Permanent Markers

Test your markers on a sample of the wood your project is made of, to see if the markers will spread or bleed into the wood. If it does and you do not like that, apply an acrylic sealer to the project first.

Markers work best on light woods. The wood grain often shows through markers.

Plan your design first, on a piece of paper exactly the same size as the project.

THINGS TO MAKE: **LEVEL TWO**

1. Bike Rack – keep your bike and helmet up out of the way
2. 4-H bookends – traditional, practical, memorable!
3. Firewood Rack – welcome accessory for home or cottage
4. Cookbook holder – this can hold any book, leaving your hands free
5. Sawhorse – a great thing to have. Better make two.
6. Magazine Rack – simple, clean, easy to move!
7. Tool Box.

Bike Rack

This rack holds a bike with a horizontal crossbar. The rack looks like a small book shelf, with two long supports that stick out and hold the bike's frame between the seat and handle bars. There is room for keys and a water bottle on the shelf and you can add pegs to hold your helmet.

Make a cardboard model of this bike rack first, so it is the correct depth for your bike and accessories. Making a model also helps prevent mistakes and waste.

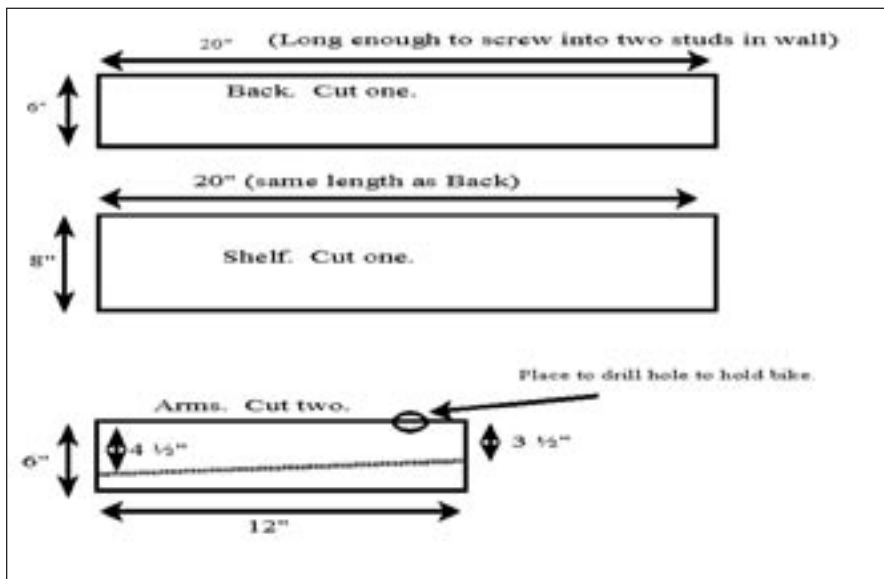

Plan to secure this to the studs in the wall. Find out how far apart the studs in the wall are. Build your bike rack to be slightly wider.

Materials

- 1 scrap 1x8, at least 24" long
- 1 scrap 1x6, at least 46" long
- 1 scrap dowel, at least 9" long
- 4 3/8" x 2 2" lag bolts, with washers (to attach it to the wall)
- 10 No. 10 x 1 2" flathead wood screws
- 6 d finishing nails
- wood glue
- sandpaper, 100-grit and 150-grit
- a jar lid, about 6" in diameter
- piece of wax candle (to rub on the screws)
- varnish
- paintbrush
- rags and newspaper
- turpentine or mineral spirits

Tools

- marking tools
- C-clamp
- handsaw
- hammer
- hand drill with 5/32" bit
- screwdriver
- coping saw
- brace with 3/8" and 1" bits
- rasp

Cut list

- 1 1 x 6 x 20" (The back)
- 2 1 x 6 x 12" (The arms the bike rests on)
- 1 1 x 8 x 20" (The shelf on top)
- 3 3/8" dowels, each 3" long (pegs)

Note that the back and shelf on top may have to be longer if you want to secure this to the studs in the wall.



Instructions

1. Make a cardboard model first.
2. Mark, clamp and cut the pieces listed.
3. Lay one of the supports on the work surface. On one end, mark a point 4 1/2" from the side. On the other end of the support, mark a point 3" from the side, on the same face of the support. Draw a line from one point to the other. The line will slope.
4. Clamp and cut on this line.
5. Repeat steps two and three for the other support.
6. To make a curved end on the support, trace the jar lid on the small end of the support, so that the line connects the supports two edges.

7. Clamp and cut with the coping saw. Use your rasp to smooth down the edge.
8. Repeat steps five and six on the other support.
9. Lay both supports on the work surface, with the top edges against each other. Put a piece of scrap wood under them. Clamp each piece so that they cannot possibly move! You might need an adult to help at this point.

On the joint between the two pieces, mark a point at 2" from the narrow end of the support. This is the point at which the bike frame will hang. (At the narrow end of the support.)

10. Drill a one inch hole with the brace and bit at the 2" mark. You will be cutting one hole, which will make a semi circle in each support. Neat, eh? Test that this hole is big enough to hold the frame of your bike.
11. Assemble the pieces to see how they will all go together.

With a helper, hold it against your bike to make sure the supports are the correct size. Is everything fitting together and making sense?

With a pencil, mark where the supports touch the back and sides. Determine where to drive the screws. With an adult helper, decide where to drill for the lag bolts.

12. Protect the work surface with scrap wood. Bore the marked holes using either the hand drill or brace and bit.
13. Sand all the parts with the sandpaper. Wipe off the dust.
14. Glue and screw the wide ends of the supports to the back of the bike rack. The top edges of the supports should be even with the top edge of the top edge of the back.
15. Glue and screw the shelf to the back and the supports. Avoid getting glue on the parts of the support which will be exposed.
16. Put a drop or two of wood glue into each peg hole. Tap or push a peg into each hole.
17. Sand the project carefully. Wipe off the dust and finish the bike rack with varnish.
18. When your bike rack is 100% dry, mount it at an appropriate height, on a wall using the lag bolts.

If you are making this as a gift for someone, have that person help decide at which height you should install the rack.
19. Take a picture. Write this accomplishment in your record book! Congratulations!

4-H Bookends

Materials

- 1 18 mm x 135 mm x 900 mm (wood or plywood)
- 14 38 mm finishing nails
- sandpaper
- paint or varnish

Tools

- crosscut handsaw
- coping saw
- hammer
- eye protection

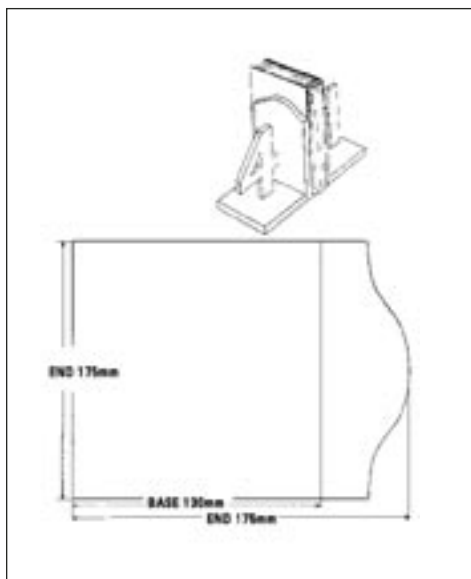

Instructions

1. Cut two bases 135 mm by 130 mm with the crosscut saw.
2. Cut two ends 135 mm by 175 mm with the crosscut saw.
3. Trace the rounded tops of the ends and cut with the coping saw.
4. Trace the 4" and the H. Cut these out with the coping saw.
5. Sand all the pieces smooth.
6. Glue and nail the ends to the bases.
7. Glue and nail the 4" to the left side bookend. Glue the H to the right side bookend. (Otherwise you will have a H-4" bookend.)
8. Varnish or paint your project.
9. Have someone take your picture with your bookends. Congratulations!

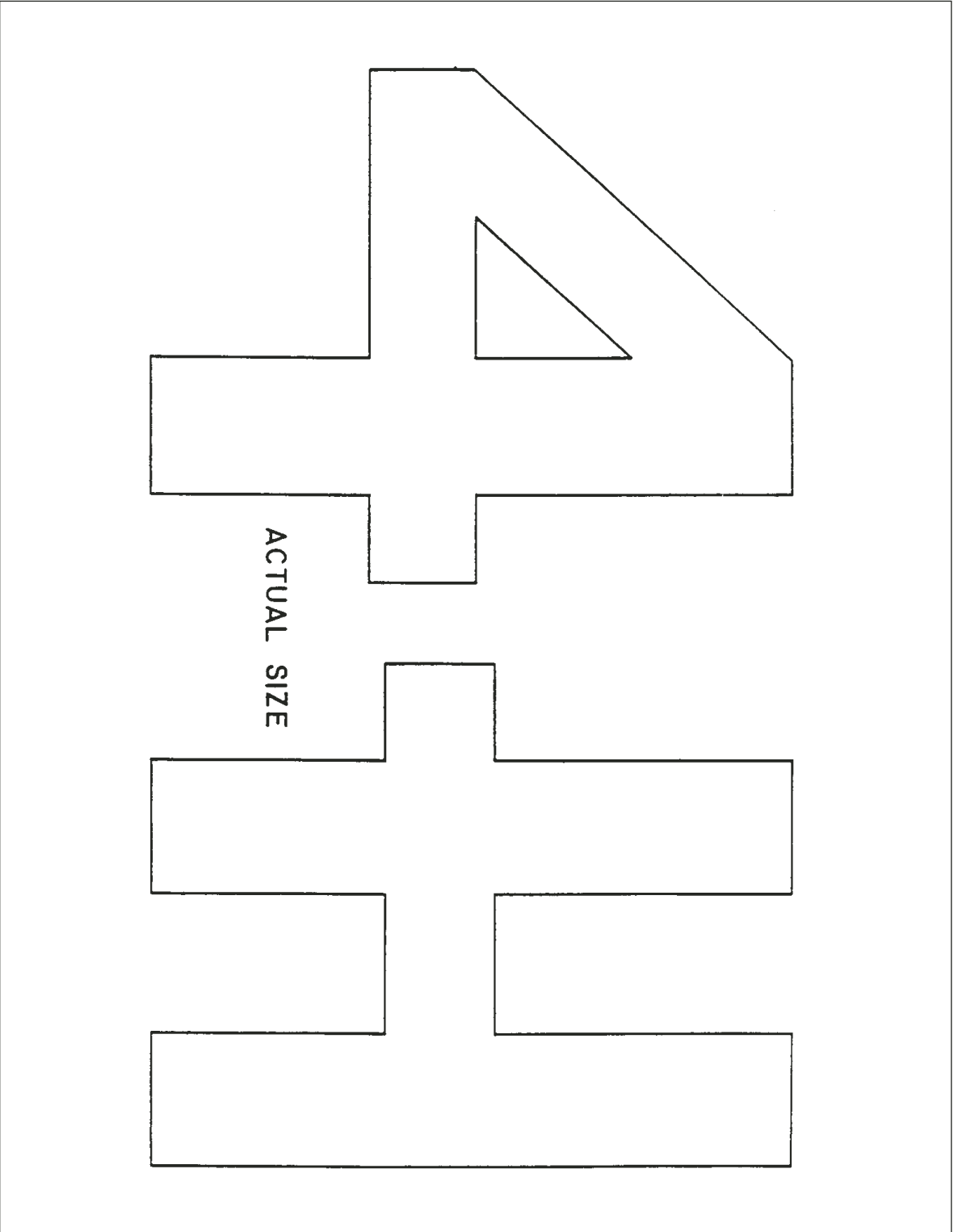

Firewood Rack

Materials

- 2 38 mm x 190 mm x 610 mm (base)
- 2 38 mm x 190 mm x 610 mm (base)
- 11 19 mm x 64 mm x 450 mm (slats)
- 26 38 mm #8 screws
- glue
- sandpaper
- outdoor stain

Tools

- jigsaw
- crosscut handsaw
- drill
- clamps
- screwdriver
- string and pencil
- clamps

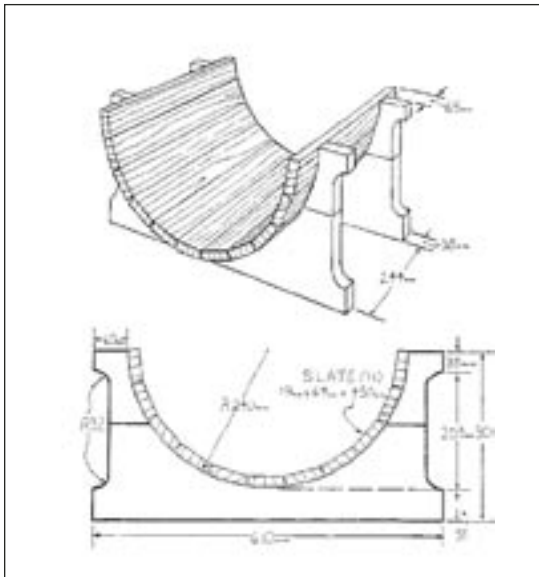

Instructions

1. Glue one 38 mm x 140 mm piece to a 38 mm x 190 mm piece to make one piece of wood that is 38 mm x 330 mm x 610.
2. Repeat step one.
3. Cut the glued pieces of wood down to 38 mm x 300 mm x 610 mm.
4. Using the string and pencil, nail the string to the middle of the top side (at 305 mm). Tie the pencil at 240 mm in the string. Draw a half circle with the pencil on the wood.
5. Repeat for the other base piece.
6. Cut out the half circles with the jigsaw.
7. Draw a cut at each end of the frame pieces that measure 200 mm by 32 mm, with rounded corners. You can use a jar lid for tracing the rounded corners. Cut these out with the jigsaw.

(This step is for appearances only, but it does look better than a straight end.)

8. Sand all the wood to remove sharp or splintering edges.
9. Clamp the base pieces so they are 244 mm apart from each other (measuring from the inside edges). If you do not have clamps, you could carefully nail or screw them to 2 x 4's from below at the correct distance. Then remove the 2 x 4's after all the slats are attached.
10. Drill two pilot holes at each end of two slats at 78 mm. These will be the top slats.
11. Drill pilot holes 78 mm from the end of all the other slats, in the centre of the slat.
12. Glue and screw the slats in place, starting at the bottom and alternating sides as you work your way upwards. The slats should stick out 65 mm past the end of the base pieces at both ends. (See diagram.)
13. Sand and wipe.
14. Stain your firewood rack with a tough outdoor stain. Or you can leave it plain, if that's your pleasure.
15. Take a picture for your record book. Congratulations. I bet it looks nice.

Source: Saskatchewan 4-H Unit Two : The 4-H Woodworker.

Cookbook Holder

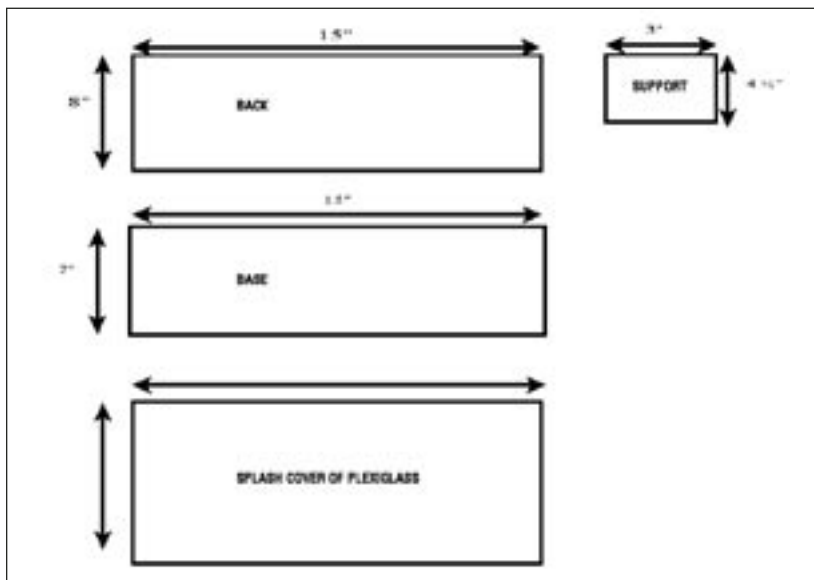

Materials

- 1 2 x 15 x 8" (back)
- 1 3/4" x 7" x 15" (base)
- 1 3/4" x 3" x 4 2" (support)
- 1 1/8" x 12" x 15" (splash cover of plexiglass)

Tools

- circular saw
- jigsaw
- jar lid
- sander

Instructions

1. Measure and cut all the wood and the plexiglass. Sand lightly. Wipe.
2. Cut the bottom edge of the base to an angle of 15 degrees. This allows the book to slant back, so it will not fall forward.
4. Mark out where the slots should be in the base, to hold the back and the piece of plexiglass. These slots will also be cut at a 15 degree angle, so that the plexiglass will also slant backwards and hold the book pages open. You will cut four slots for the plexiglass, to accommodate various thicknesses of books.
5. All the slots will be 1/4" deep.
6. The slot for the base should be the width of the back so it will fit snugly. The slot for the plexiglass should be 1/8" wide. Space the slots for the plexiglass evenly between the front and the slot.
7. Check before you cut that you will be cutting the slots angling towards the back, not the front!
8. Cut the support piece. This piece is also angled at 15 degrees.
9. Screw the support piece to the base, making sure the back support is lined up with the slot for the base.

10. Apply glue to the sloped edge of the back support, as well as in the 2" slot.
11. Put the back piece in place. Clamp together overnight.
12. Use a finishing oil on the cookbook holder.
13. Cut out the piece of plexiglass. Round off the top edges. Sand down the edges to smooth them
14. Take a picture for your record book. Congratulations.

Note: You could cut out a decorative shape, such as a heart, out of the top centre of the holder. Rasp and sand it well.

Sawhorse

Materials (for sawhorse with 24" legs)

- 1 2" x 4" x 12' (sound wood, free from splits, knots or other weakening defects) for the legs and the beam
- 1 piece 1" x 6" x 24" – for the support under each end of the beam
- 8 No. 14, 3" flathead wood screws
- 20 No. 12, 2" flathead wood screws
- 20 4d finishing nails
- Colourless penetrating wood finish, such as boiled linseed oil or varnish with paint thinner or commercial wood seal

Tools

- hammer
- crosscut saw
- screwdriver
- countersink
- combination square
- sandpaper
- tape rule
- T bevel
- plane

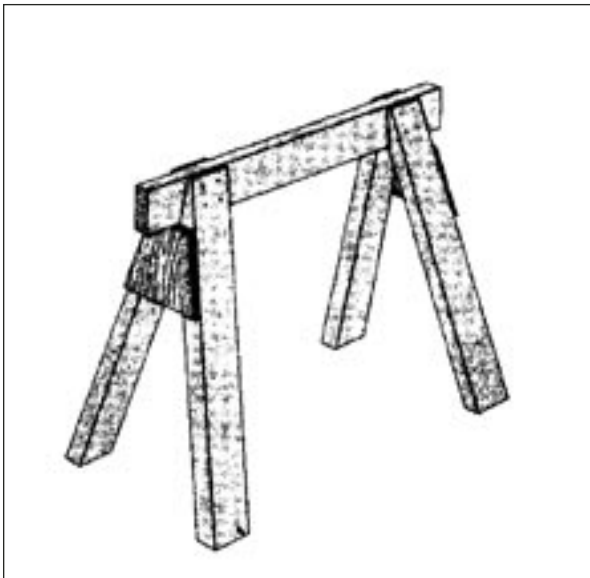

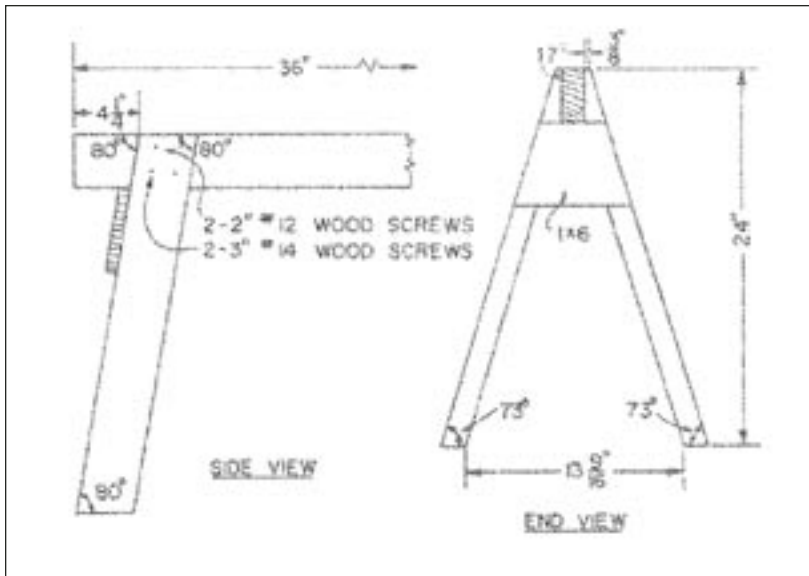

Instructions

1. Lay out and cut all pieces. Refer to the diagram for the angles of cuts on the legs.
2. Assemble sawhorse as shown with nails.
3. Drill pilot holes and install screws.
4. After all the legs are marked and cut out, cut 1 1/4" off the tapered end to give a narrow, flat end section. The flat end section will be flush with the top of the beam
5. Sand lightly.
6. Finish with your chosen finish.

Note: To make a sawhorse even sturdier, add supports on the inside of the legs too.

Source: National 4-H wood Science Committee. Building Bigger Things. Chevy Chase, MD. : National 4-H Council of the United States of America, 1987.

Magazine Rack

This design goes together quickly. A slot in each piece fits into the other to form a sturdy, yet simple rack. Comes apart easily for moving. A great gift idea for someone's dorm room or first apartment!

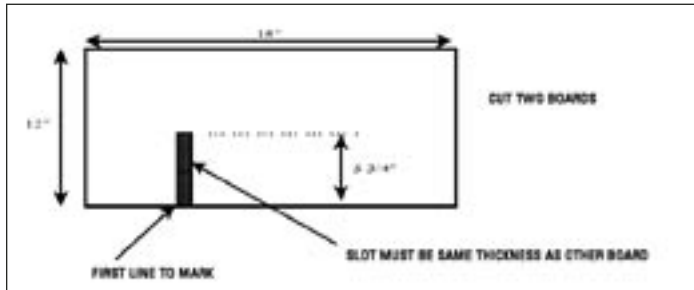

Materials

- 1 scrap of 1 x 12", at least 32" long (or glue and clamp together some 1 x 6)
- sandpaper, 100-grit and 150-grit
- varnish
- mineral spirits or turpentine
- 1" paintbrush
- rags and newspaper

Tools

- measuring and marking tools
- C-clamp
- handsaw
- coping saw
- rasp

Cut List

- 2 1 x 12 x 16" sides

Instructions

1. Square the end of the wood.
2. Cut two 16" long pieces from the 1 x 12.
3. Lay one piece on the work surface. You are going to mark where to cut the slot. This slot has to be the actual thickness of the other board. Measuring from one cut end, mark a point at 5 inches. Mark a second point which will be at 5 inches plus the thickness of the second board.
4. Measuring from the edge of the piece, lightly draw a line through each of the marks you just made. You will have two lines parallel to each other.
5. From that same edge, measure and mark a point 5 3/4" down, between the two faint lines. Connect the two lines across this point, using your try square to make sure the line is square.
6. Clamp the wood to the work surface. Cut the two faint lines with the handsaw, up to the latest line which crosses the two lines. Tip your saw up at the end of the cut, so that the cut will have a square end.
7. Cut along the short line with the coping saw. You may have to drill a small hole so you can turn your coping saw to point the right way. Sand the rough inside edge with the rasp and then the sandpaper.
8. Repeat steps two to seven with the other piece of wood.
9. Slide the two slots together. The longer ends of the wood should be on top, so the rack will hold more magazines.
10. Separate the sides. Sand all surfaces. Wipe away the dust.
11. Give each side at least two coats of varnish, sanding lightly between coats.
12. When the sides are completely dry, put them together. Have someone take your picture with your new magazine rack. Congratulations!

Toolbox

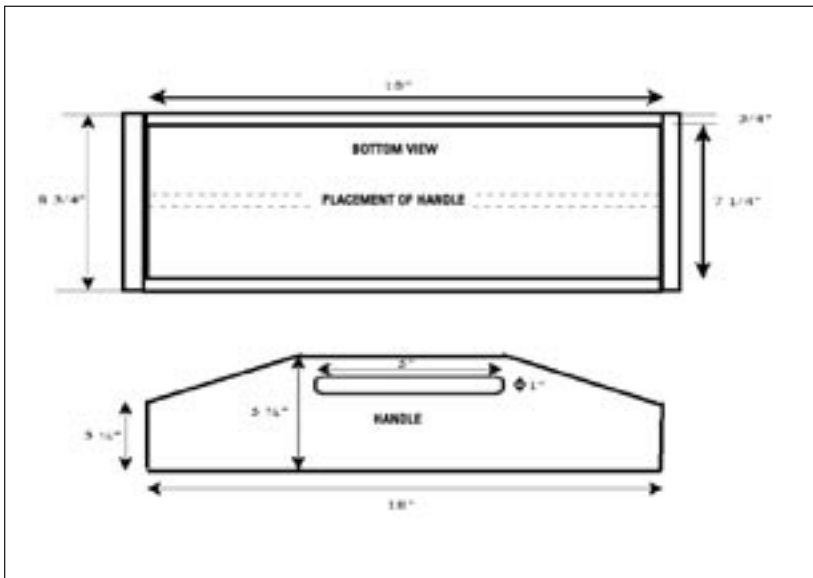

Materials

- 1 1" x 8" x 18" (bottom)
- 2 1" x 4" x 18" (Sides)
- 1 1" x 4" x 10" (Ends)
- 1 1" x 6" x 18" (handle)
- 4 #8, 1 2" flathead wood screws
- 25 #8, 2" flathead wood screws
- fine grit sandpaper

Tools

- saws
- screwdriver
- round wood rasp or file
- drill with 1" bit
- pilot hole bits to fit screws and countersink

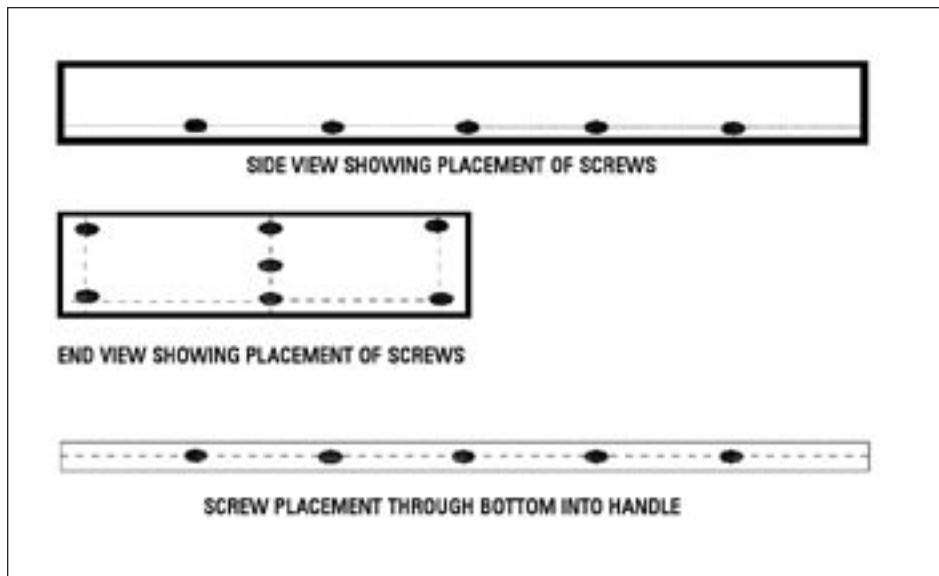

Instructions

1. Cut pieces to size (see diagram).
2. Mark and cut the angled cuts on the handle, leaving 1/16" or so for sanding.
3. Mark the handle hole. Bore a 1" hole at each end of the mark and saw out the rest. Use the rasp or file to even and round out the edges. Sand and smooth all sides and edges.
4. On the 8 x 18 bottom piece, draw a centre line lengthwise. Mark and drill countersink holes every three inches on this line. Sand smooth all sides and edges. Screw the bottom to the handle with 2" screws.

Tip: When use slotted screws, line up all the slots the same way. It looks more professional.

5. In the side pieces, drill the countersink holes 3/8" from the bottom edge. Space the holes as shown on the diagram. Sand smooth all sides and edges. Use 2" screws to fasten both sides to the bottom piece.
6. Add the ends in the same way. Use 1/2" screws at the bottom corners so you do not hit the screws holding the side pieces.
7. For extra strength, drill and countersink the holes in each end piece to hold the handle. Use a 2" screw in each hole.
8. Paint or stain your tool box to personalize it.
9. Take a picture for your record book. Congratulations! Enjoy using your new tool box.

MEMBERS: I CAN CHECKLIST

Leader Signature

Safety

- Meet all safety objectives of level two. _____
- Ask another member to stop if I see unsafe practices or hazards. _____
- Explain and demonstrate safe shop practices. _____
- Recall and practice safety procedures. _____
- Locate first aid kit. _____
- Locate closest phone. _____
- Recall the phone numbers for emergency help. _____
- Explain and demonstrate safe handling procedures of new tools and materials. _____
- Can evaluate equipment for dust management. _____
- The nature of wood. _____
- Identify at least five types of wood and suggest uses for them. _____
- Demonstrate how to remove dents in wood. _____
- Apply knowledge of wood characteristics when selecting wood for a project. _____

Drawing for Building

- Explain benefits for drawing before building a project. _____
- Draw isometric and orthographic drawings of a simple project, including measurements. _____
- Accurately find points on drawing that match points on an object. _____

Tools

- Be able to transfer a drawing pattern onto wood. _____
- Accurately enlarge a pattern. _____
- Identify and explain use of chisels, power drill, power sander, jigsaw, brace and bit. _____
- Explain/demonstrate safe handling of above named tools. _____
- Use tools to complete a project. _____
- Care for and store tools properly. _____

Using Screws

- Explain why we would use screws instead of nails. _____
- Identify at least two different types of screws and their use. _____
- Name the parts of a screw. _____
- List advantages/disadvantages of types of screws. _____
- Explain and demonstrate how to put a screw into wood without splitting or breaking the wood. _____
- Explain the sizing of screws (gauge). _____
- Given two pieces of wood to be joined, select the correct size of screw to be used. _____
- Select the right size of screwdriver to be used. _____
- Explain and demonstrate how to avoid stripping screws or ruining the head. _____
- Demonstrate how to cover screws in a finished project. _____

Measurement Tools

- Identify and demonstrate accurate use of a try square. _____
- Identify and demonstrate accurate use of a steel utility square or framing square. _____
- Identify and demonstrate accurate use of a steel combination square. _____
- Identify and demonstrate accurate use of a pencil compass. _____
- Identify and demonstrate accurate use of a scratch awl. _____

Glue

- Explain how glue works. _____
- Select appropriate glue for a job. _____
- Demonstrate correct gluing technique. _____
- Explain how glue can affect finishing. _____
- Demonstrate safe and economic clean up and storage of glue. _____

Sanding

- Identify orbital, belt and straight sanders and their advantages/disadvantages. _____
- Explain how each type of sander works. _____
- Select appropriate sander for the job at hand. _____
- List and demonstrate dust management techniques. _____
- List sources for additional information on dust management. _____

Cutting Angles

- Explain and demonstrate the use of a mitre box to cut angles of various degrees. _____
- Identify situations for use of mitred corners. _____
- Share tips for accurate cutting. _____

Finishing

- Explain differences between paint and varnish and how to decide which product to use. _____
- Provide for adequate ventilation while using finishing products. _____
- Give three tips re: finishing. _____
- Demonstrate care and clean-up of tools and materials. _____
- Explain/demonstrated how to hide nail or screw holes. _____
- Demonstrate at least one of: splattering, stippling, rag rolling, dragging, use of a marine sponge, use of permanent markers as decorative finishes. _____
- Dispose of used rags in a safe manner, to prevent fire. _____

EVALUATION

Your input is a valuable asset to the 4-H program!

As you go through the project year, write your comments and suggestions about the project on this form. When you complete your project, mail this form to us. We want to hear from you!

Woodworking Project Evaluation

Evaluation Date: _____

Please Tell Us

Which techniques and skills did you learn and use for this project?

What did you like best about completing this project?

Are you pleased with your project? Is there anything you would change if you were to do the project again?

What are you going to do with your project?

How long did it take you to finish your project?

Additional Comments?
